

# MISCHEN – DOSIEREN - ABFÜLLEN



## EASY TO USE LINZ FLOWCONTROL SYSTEME

die Software deckt nahezu alle Anwendungsbereiche ab  
für ein breites Spektrum für Lacke, Kleber, Leim, Epoxide  
auf wasserlöslicher sowie Lösemittel haltige Materialien



- use know how -

K-MIX based of SIMATIC Technology

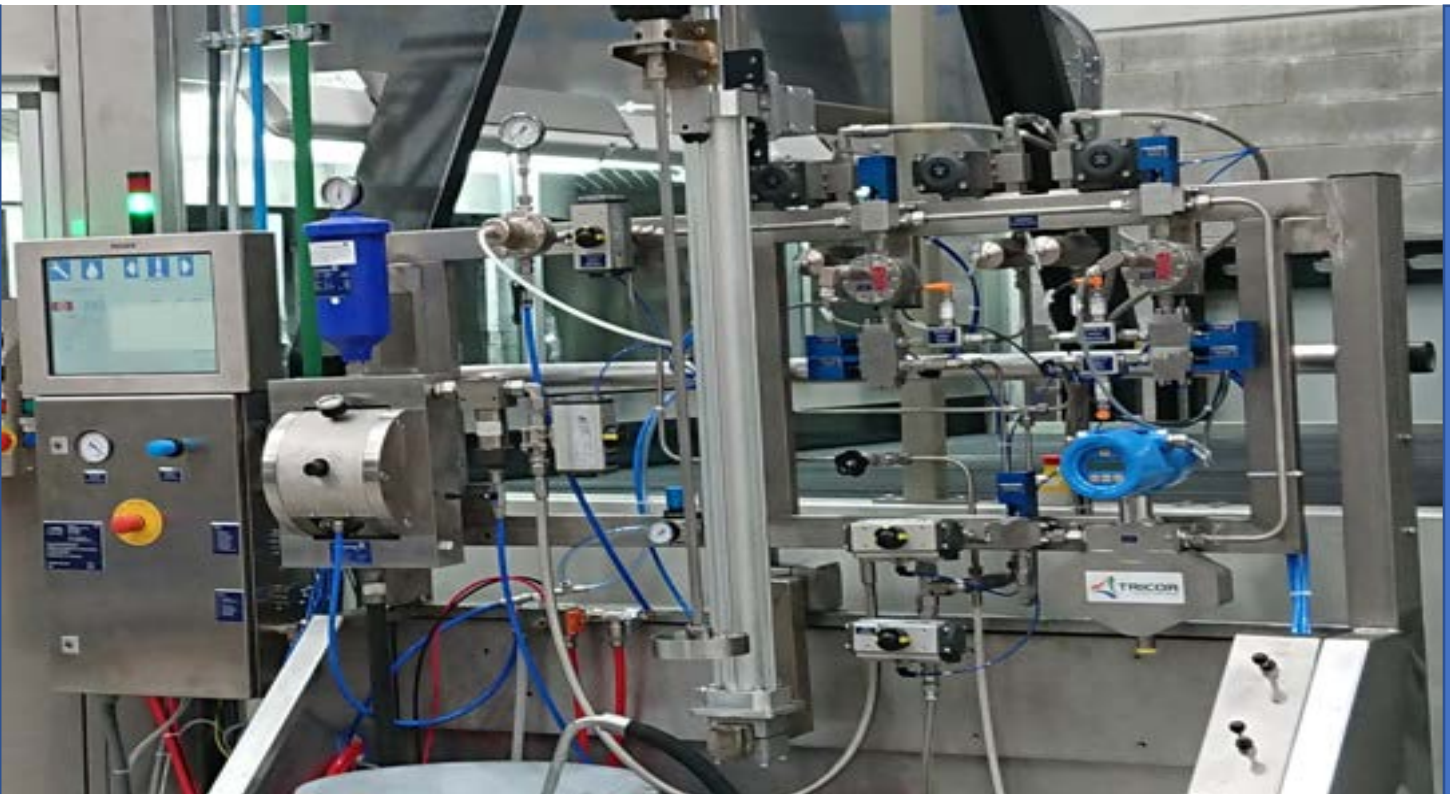

Rainer Linz  
Oberflächentechnik GmbH  
Linzer Strasse 1  
A-3003 Gablitz

☎ +43 2231 65191-0  
✉ office@linz-gmbh.com  
🏠 www.linz-gmbh.com

**FlowControl FC2.0** basierend auf SIMATIC TECHNOLOGIE  
 manuelle Bedienung per Touch – Automatikbetrieb mit PN/PN Koppler



support from beginning  
**SERVICE – UPDATE BY VPN REMOTE CONTROL**

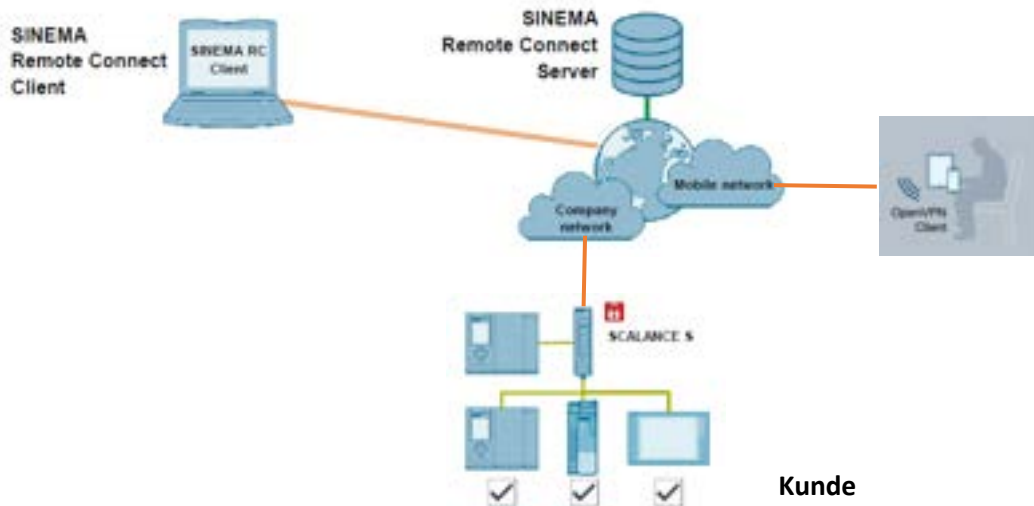

Rainer Linz  
 Oberflächentechnik GmbH  
 Linzer Strasse 1  
 A-3003 Gablitz

+43 2231 65191-0  
 office@linz-gmbh.com  
 www.linz-gmbh.com

## TECHNISCHE DATEN, OPTIONEN

- **Software:** FlowControl FC2.0
  - **Komponenten:** 1 – 4
  - **Arbeitsdruck:** 1-250 bar (höhere Drücke optional)
  - **Durchfluss-Messung:** Coriolis System / Zahnradzähler / Induktive Systeme
  - **Materialdosierung:** Kolbenpumpen, Faltenbalgpumpen, Membranpumpen, Kolben-dosierer
  - **Mischsystem:** Injektions System, Dispense System
  - **Mischungsverhältnis:** 0,1:1 - 1 : 1
  - **Genauigkeit:** abhängig von System und Material 0,5 % - xxxx
- die Zusammenstellung der Anlage erfolgt, aufgrund der Kundenvorgaben.

**Messgeräte:** Durchfluss (0,01 – xxx kg/min.)

- Coriolis Massendurchfluss
- Induktive Durchflussmesser



- Zahnradzähler



Rainer Linz  
Oberflächentechnik GmbH  
Linzer Strasse 1  
A-3003 Gablitz

☎ +43 2231 65191-0  
✉ office@linz-gmbh.com  
🏠 www.linz-gmbh.com

Zahnradpumpen:

verschiedene Baugruppen, mit verschiedenen Fördervolumen und Zahnradkombinationen

- ADLC beschichtet (bessere Spülbarkeit)
- TITAN beschichtet (für abrasive Produkte)
- Edelstahlausführung
- verschiedene Zahnradgeometrien
- Servo geregelt

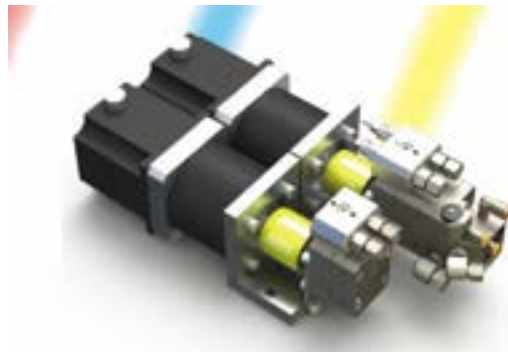

Exzenter Pumpen:

verschiedene Fördervolumen

- Edelstahl
- verschiedene Statoren



Rainer Linz  
Oberflächentechnik GmbH  
Linzer Strasse 1  
A-3003 Gablitz

☎ +43 2231 65191-0  
✉ office@linz-gmbh.com  
🏠 www.linz-gmbh.com

## Zuführungspumpen:

Membranpumpen:

verschiedene Baugrößen und Förderleistungen

- Edelstahlausführung
- Baugrößen: G ¼" - G ½" - G 1"



Kolben Pumpen:

verschiedene Baugrößen und Förderleistungen

- Kolbenpumpen
- Faltenbalgpumpen für Luft- und Feuchtigkeitsreaktive Materialien



Rainer Linz  
Oberflächentechnik GmbH  
Linzer Strasse 1  
A-3003 Gablitz

☎ +43 2231 65191-0  
✉ office@linz-gmbh.com  
🏠 www.linz-gmbh.com

## Application 2 Komponenten wasserlöslicher Kleber

### Automatik Applikation



### Hand Applikation



### Kolben Dosierer



Rainer Linz  
Oberflächentechnik GmbH  
Linzer Strasse 1  
A-3003 Gablitz

☎ +43 2231 65191-0  
✉ office@linz-gmbh.com  
🏠 www.linz-gmbh.com

**Airless – Elektrostatik 2 K Applikation**



Automatische Spülbox  
nach erreichter Topfzeit



Airless Handpistole



Airless Assistant



Airless-Pumpe



Rainer Linz  
Oberflächentechnik GmbH  
Linzer Strasse 1  
A-3003 Gablitz

☎ +43 2231 65191-0  
✉ office@linz-gmbh.com  
🏠 www.linz-gmbh.com

## Automatische Beschichtung 3 K System HVLP

FlowControl (Rezepte werden eingescannt)



Materialzuführung, Membranpumpen mit Rührwerken mit Zeitschaltung, Niveau Kontrolle mit Liquidcup



Zahnrad-Dosierung – Durchflussmessung Coriolis



Rainer Linz  
Oberflächentechnik GmbH  
Linzer Strasse 1  
A-3003 Gablitz

☎ +43 2231 65191-0  
✉ office@linz-gmbh.com  
🏠 www.linz-gmbh.com



## Durchflusssteuerung für 1 u. 2 Komponenten Kleberauftragsanlagen

Steuerung Siemens SPS



Kleberbeschichtungslinie



Komplettlinie mit Teileerkennung, Kleber-Raupenauftrag

Dosierpumpe 50 cc/U

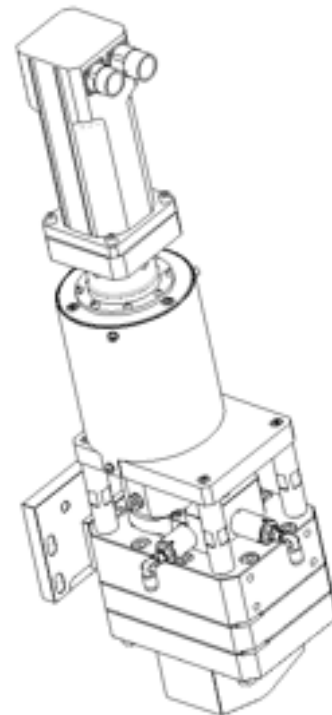

Rainer Linz  
Oberflächentechnik GmbH  
Linzer Strasse 1  
A-3003 Gablitz

☎ +43 2231 65191-0  
✉ office@linz-gmbh.com  
🏠 www.linz-gmbh.com

## Application 2 Komponenten PU Kleber



Handpistole MP\_10 H



Automatische Auftragspistole MP\_10 A



## Zubehör für Misch- und Dosier Applikationen:



Rainer Linz  
Oberflächentechnik GmbH  
Linzer Strasse 1  
A-3003 Gablitz

☎ +43 2231 65191-0  
✉ office@linz-gmbh.com  
🏠 www.linz-gmbh.com

Materialwechselventile

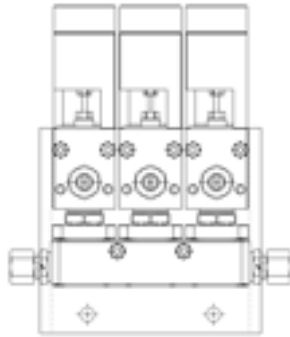

Dynamischer Mischer mit Servo Motor



Injektionsventile

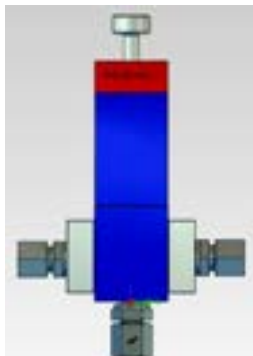

Dosierventile

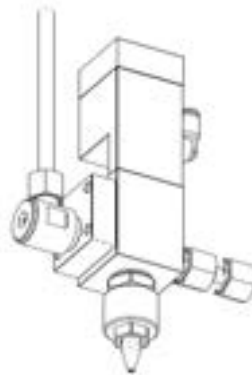

different types and sizes of static mixer

different nozzle sizes and design



Rainer Linz  
Oberflächentechnik GmbH  
Linzer Strasse 1  
A-3003 Gablitz

☎ +43 2231 65191-0  
✉ office@linz-gmbh.com  
🏠 www.linz-gmbh.com